

2-JAW PARALLEL GRIPPERS

SERIES GP100

▶ PRODUCT ADVANTAGES



“The precise”

- ▶ **Gripper jaws 20% longer than similar products**
Low-backlash ball guide, guided into a steel housing, for maximum precision
- ▶ **Near constant gripping force for different gripper jaw lengths**
Makes it possible to cover a high range of variants with only one gripper
- ▶ **Failure-free continuous operation**
Our uncompromising “Made in Germany” quality guarantees up to 10 million maintenance-free gripping cycles

▶ THE BEST PRODUCT FOR YOUR APPLICATION



- ▶ **Our products love the challenge!**
Extreme conditions, all over the world—our tried and tested components and systems give you limitless possibilities:
Find the best product for your specific use:
www.zimmer-group.de

► BENEFITS IN DETAIL

- ① **Gripper jaw**
 - individual gripper finger mounting
- ② **Wedge hook mechanism**
 - synchronized the movement of the gripper jaws
 - high force transfer
- ③ **Ball guide**
 - smooth running guides via rolling friction
 - near constant force in various gripping jaw lengths
- ④ **Removable centering sleeves**
 - quick and economical positioning of the gripper fingers
- ⑤ **Mounting block**
 - mounting for inductive proximity switch
- ⑥ **Mounting and positioning**
 - mounting possible from several sides for versatile positioning
- ⑦ **Drive**
 - double-acting pneumatic cylinder
- ⑧ **Energy supply**
 - possible from several sides

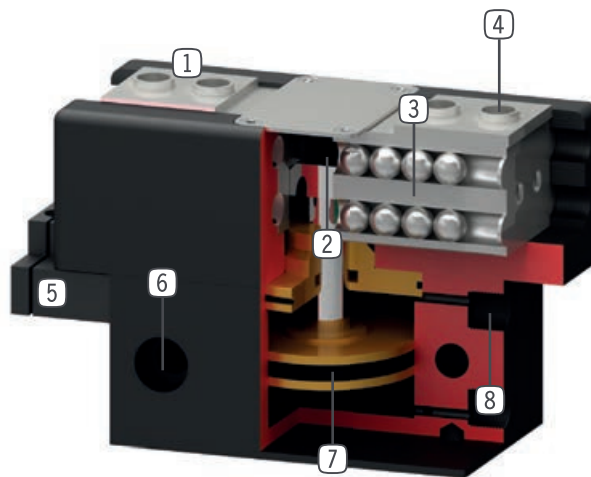

► FURTHER INFORMATION IS AVAILABLE ONLINE



► Technical Information

All information just a click away at: www.zimmer-group.de
 Find data, illustrations, 3D models and Installation instructions for your installation size using the order number for your desired product.
 Quick, clear and always current.



2-JAW PARALLEL GRIPPERS SERIES GP100

1

Series GP100 / 2-Jaw Parallel Grippers / pneumatic / Grippers

Installation Size: GP103

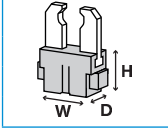

Dimension			
Width [mm]	Height [mm]	Depth [mm]	
34	35	17	

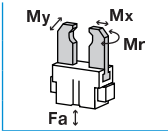

Force and moment			
Mr [Nm]	Mx [Nm]	My [Nm]	Fa [N]
0.5	0.5	0.5	80

Technical Data*			
Stroke per jaw [mm]	Gripping force [N]		Weight [kg]
	opening	closing	
3	41	21	0.09

Order no.	GP103
------------------	--------------

*All data measured at 6 bar

Gripping force diagram

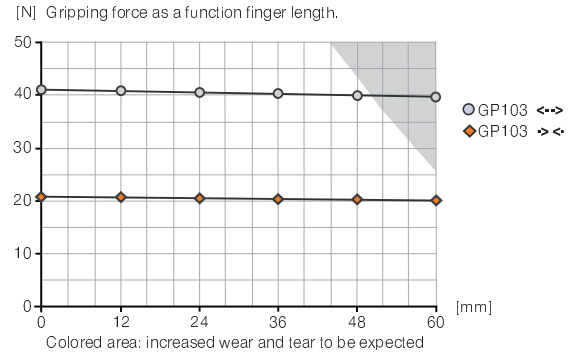

Installation Size: GP104

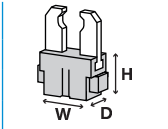

Dimension		
Width [mm]	Height [mm]	Depth [mm]
42	38	20

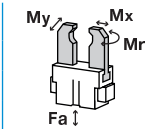

Force and moment			
Mr [Nm]	Mx [Nm]	My [Nm]	Fa [N]
1	1	1	120

Technical Data*			
Stroke per jaw [mm]	Gripping force [N]		Weight [kg]
	opening	closing	
4	104	84	0.14

Order no.	GP104
------------------	--------------

*All data measured at 6 bar

Gripping force diagram

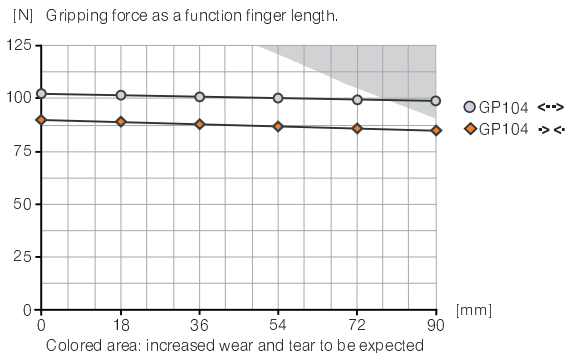

Installation Size: GP105

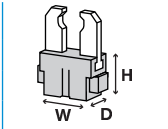

Dimension		
Width [mm]	Height [mm]	Depth [mm]
52	45	28

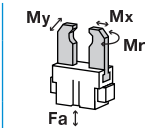

Force and moment			
Mr [Nm]	Mx [Nm]	My [Nm]	Fa [N]
2	2	2	180

Technical Data*			
Stroke per jaw [mm]	Gripping force [N]		Weight [kg]
	opening	closing	
5	230	210	0.31

Order no.	GP105
------------------	--------------

*All data measured at 6 bar

Gripping force diagram

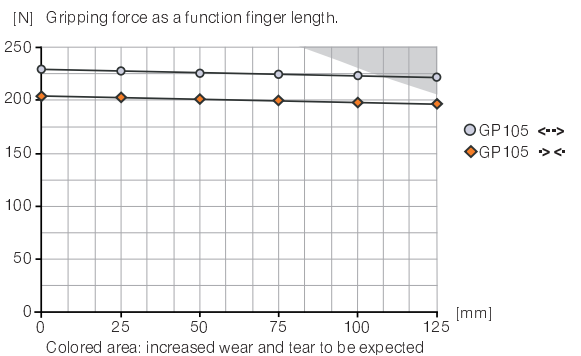

Installation Size: GP110

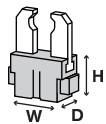

Dimension

Width [mm]	Height [mm]	Depth [mm]
80	62	40

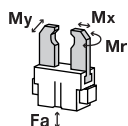

Force and moment

Mr [Nm]	Mx [Nm]	My [Nm]	Fa [N]
8	8	8	250

Technical Data*

Order no.	Stroke per jaw [mm]	Gripping force [N]		Weight [kg]
		opening	closing	
GP110	10	430	380	0.9

*All data measured at 6 bar

Gripping force diagram

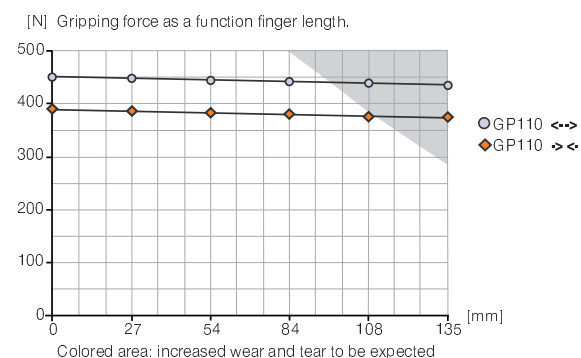

Installation Size: GP115

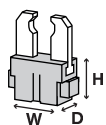

Dimension

Width [mm]	Height [mm]	Depth [mm]
120	82	54

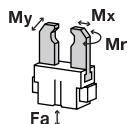

Force and moment

Mr [Nm]	Mx [Nm]	My [Nm]	Fa [N]
15	15	15	700

Technical Data*

Order no.	Stroke per jaw [mm]	Gripping force [N]		Weight [kg]
		opening	closing	
GP115	15	1000	930	2.3

*All data measured at 6 bar

Gripping force diagram

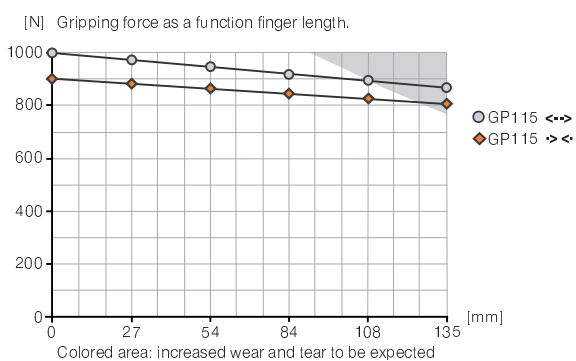

2-JAW PARALLEL GRIPPERS

SERIES GP100

▶ ACCESSORIES

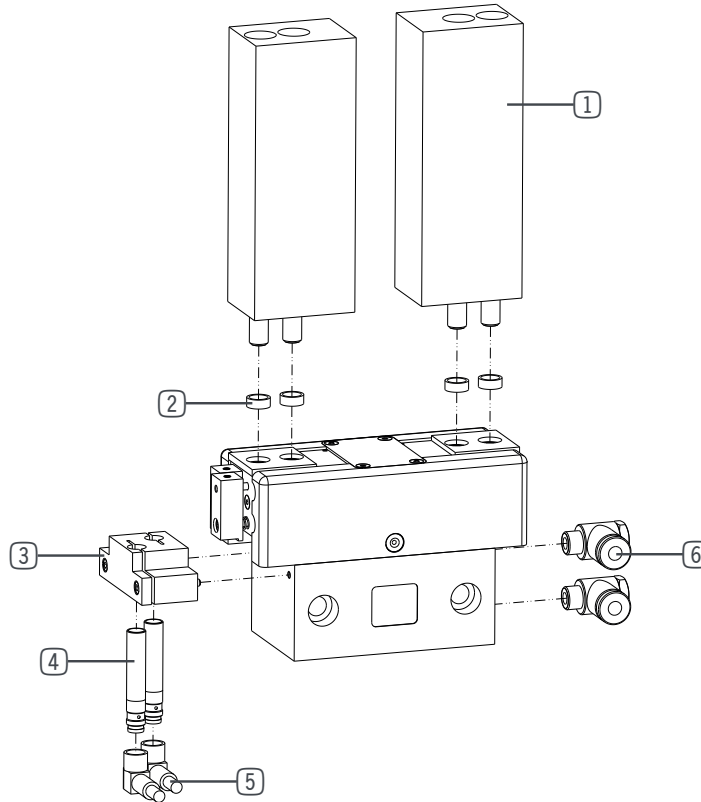

▶ Installation Size: GP103

Pos.	Accessories	Order no.
①	Universal Jaw Aluminium	UB103
①	Universal Jaw Steel	UB103ST
④	Inductive proximity switch - Cable 5 m	NJ4-E2
⑤	Plug-in connector Straight Cable 5m - Socket M8 (female)	KAG500
⑤	Plug-in connector Angled Cable 5m - Socket M8 (female)	KAW500
⑥	Straight Fittings - Barb Style Connection	GVM3
⑥	Angled Fittings - Barb Style Connection	WVM3
Delivery contents		Order no.
②	Centering Disc	BDST10300
③	Mounting block	KB4-02

▶ Installation Size: GP105

Pos.	Accessories	Order no.
①	Universal Jaw Aluminium	UB105
①	Universal Jaw Steel	UB105ST
④	Inductive proximity switch - Connector M8	NJ6.5-E2S
④	Inductive proximity switch - Cable 5 m	NJ6.5-E2-01
⑤	Plug-in connector Straight Cable 5m - Socket M8 (female)	KAG500
⑤	Plug-in connector Angled Cable 5m - Socket M8 (female)	KAW500
⑥	Straight Fittings - Quick Connect Style	GVM5
Delivery contents		Order no.
②	Centering Disc	BDST40400
③	Mounting block	KB6.5-03

▶ Installation Size: GP104

Pos.	Accessories	Order no.
①	Universal Jaw Aluminium	UB104
①	Universal Jaw Steel	UB104ST
④	Inductive proximity switch - Cable 5 m	NJ4-E2
⑤	Plug-in connector Straight Cable 5m - Socket M8 (female)	KAG500
⑤	Plug-in connector Angled Cable 5m - Socket M8 (female)	KAW500
⑥	Straight Fittings - Quick Connect Style	GVM5
Delivery contents		Order no.
②	Centering Disc	BDST40400
③	Mounting block	KB4-03

► Installation Size: **GP110**

Pos.	Accessories	Order no.
①	Universal Jaw Aluminium	UB110P
①	Universal Jaw Steel	UB110PST
④	Inductive proximity switch - Cable 5 m	NJ8-E2
④	Inductive proximity switch - Connector M8	NJ8-E2S
⑤	Plug-in connector Straight Cable 5m - Socket M8 (female)	KAG500
⑤	Plug-in connector Angled Cable 5m - Socket M8 (female)	KAW500
⑥	Straight Fittings - Quick Connect Style	GVM5
	Delivery contents	Order no.
②	Centering Disc	BDST40800
③	Mounting block	KB8-25

► Installation Size: **GP115**

Pos.	Accessories	Order no.
①	Universal Jaw Aluminium	UB115
①	Universal Jaw Steel	UB115ST
④	Inductive proximity switch - Cable 5 m	NJ8-E2
④	Inductive proximity switch - Connector M8	NJ8-E2S
⑤	Plug-in connector Straight Cable 5m - Socket M8 (female)	KAG500
⑤	Plug-in connector Angled Cable 5m - Socket M8 (female)	KAW500
⑥	Straight Fittings - Quick Connect Style	GV1-8X8
	Delivery contents	Order no.
②	Centering Disc	BDST11500
③	Mounting block	KB8-26